

▶ INTUSCAPE 6FP80R ◀

2-WAY 6" OUTDOOR BGM SPEAKER

CONCEPT

The INTUSCAPE™ 6FP80R is a compact choice to bring background music to any venue's outdoor areas. Its one-shell design from impact-proof ABS resin with a recessed baffle insert provides superior protection against rain. A PP cone woofer and a silk dome tweeter likewise withstand the rigors of outdoor use. Nonetheless, the vented design and the controlled dispersion deliver a pristine sound quality. An internal line transformer with switchable load, a real crossover - not just a capacitor - and our unique cable gland cover as well as the ball head bracket complement the elegant looks of this speaker.

FEATURES

- ▶ 6" LF driver, 80W AES power handling (vented)
- ▶ 1" silk dome tweeter & wide-dispersion HF wave guide
- ▶ Advanced passive crossover for best sound quality
- ▶ Audio-grade internal 100V line transformer (40W max)
- ▶ Mode switch for 8Ω / 5W / 10W / 20W / 40W settings
- ▶ 4P-5.0mm terminal strip for input & parallel output
- ▶ ABS resin body with M6 safety lug mounting point
- ▶ Structured scratch-resistant surface, black or white
- ▶ Rustproof aluminum front grille
- ▶ Multi-angle ball head bracket with stainless steel rod
- ▶ Waterproof cable gland cover with 2 mounting angles
- ▶ CE/ROHS compliant

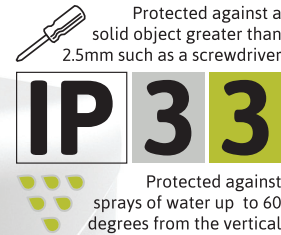

Front View (grille removed)



Rear panel structure

Black and White versions available



Rear View



Side Profile

TECHNICAL DATA

Frequency response (-6 dB).....	65Hz-20.0kHz
Sensitivity (1W/1m) / Max SPL.....	84dB / 104dB
Dispersion HxV.....	90° x 80°
Impedance.....	8Ω / 100V-5W/10W/20W/40W
Power Handling.....	80W (AES)
Drivers / Design.....	6.0" LF (vented) & 1" SDT
Material.....	ABS
Surface.....	Texture
IP Rating.....	33
Dimensions WxDxH.....	200x156x285mm
Weight.....	3.39 kg

LOGISTICS DATA

Order Number (black).....	1306701
Single unit EAN-13 (black).....	5060502923486
Order Number (white).....	1306711
Single unit EAN-13 (white).....	5060502923493
Single Carton size WxDxH.....	250x210x370mm
Single Carton gross weight.....	3.75 kg
Units per master carton.....	2
Master carton size WxDxH.....	435x265x390mm
Master carton gross weight.....	8.10 kg

INTUSCAPE 6FP80R

2-WAY 6" OUTDOOR BGM SPEAKER

FREQUENCY RESPONSE

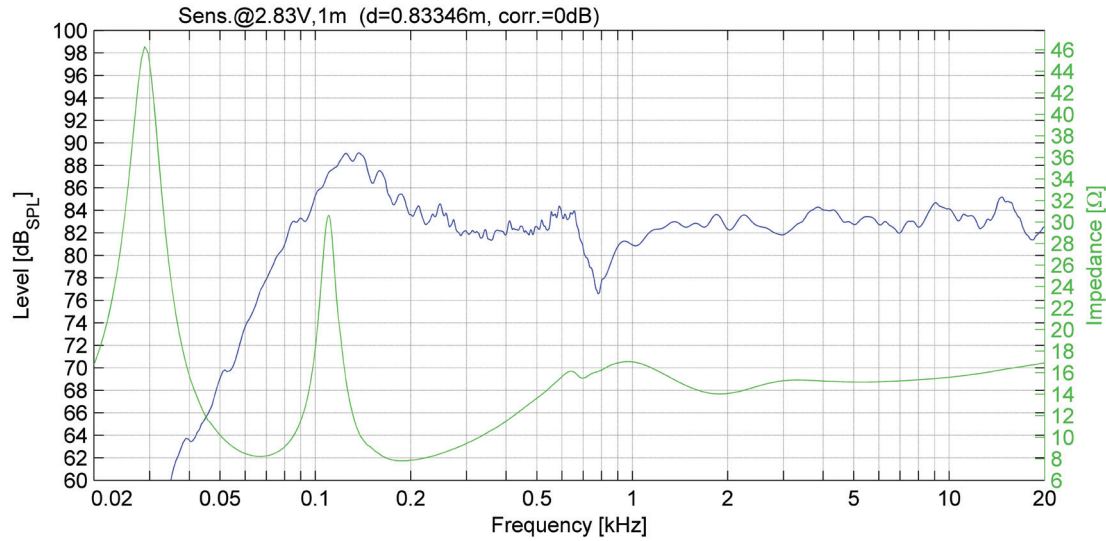

DIMENSIONS

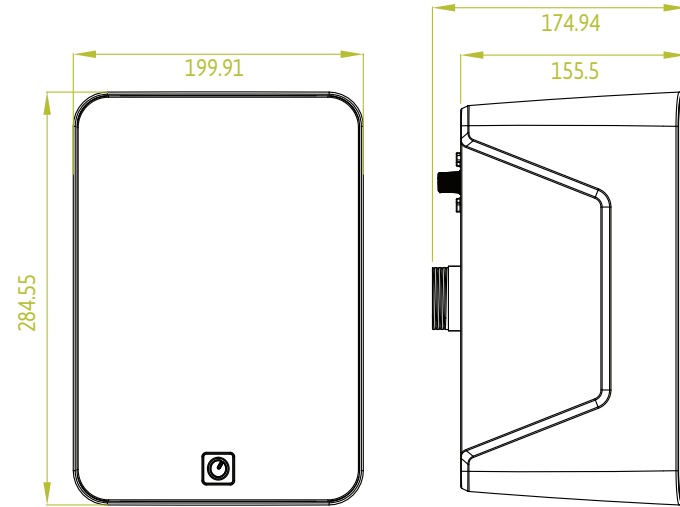

DIRECTIVITY

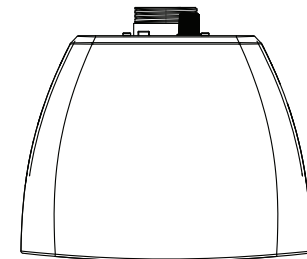
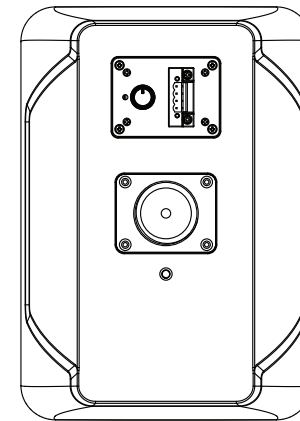
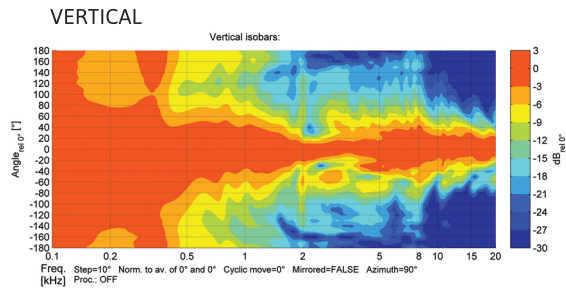
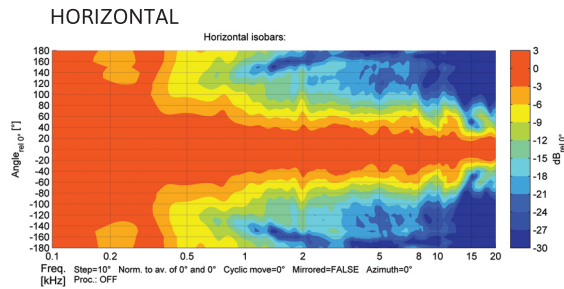

SPEAKER LOZ / HiZ

SPEAKER LOZ / HiZ